

Varenummer: 0106032  
 Beskrivelse: Seeger låsering JV 16

## Mål

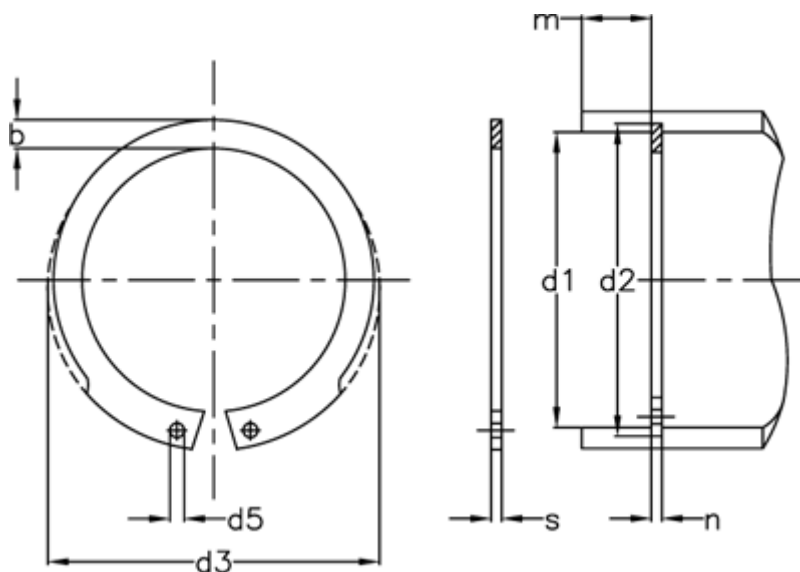

AN mm <sup>2</sup>	= 10	FRg kN	= 3.1	Tang	= ZGJ-1
b	= 2.1	FR kN	= 5.2	tol	= -0.06
Betegnelse	= JV 16	g	= 1.0	tol	= +0,42-0,13
d1	= 16	K kN-mm	= 22.7	tol	= +0,11
d2	= 16.8	m min	= 1.10	tol	= 0.1
d3	= 17.3	Nominel træk	= 1.2	vægt kg/1000	= 0.53
d5 min	= 1.3	s	= 1.00		
FN kN	= 1.67	t	= 0.40		